

AVANTE™
PLUS
SLABS DE GRANDE

A BRAND OF  **sati**, INDIA

www.avantesurfaces.com

G R A N D

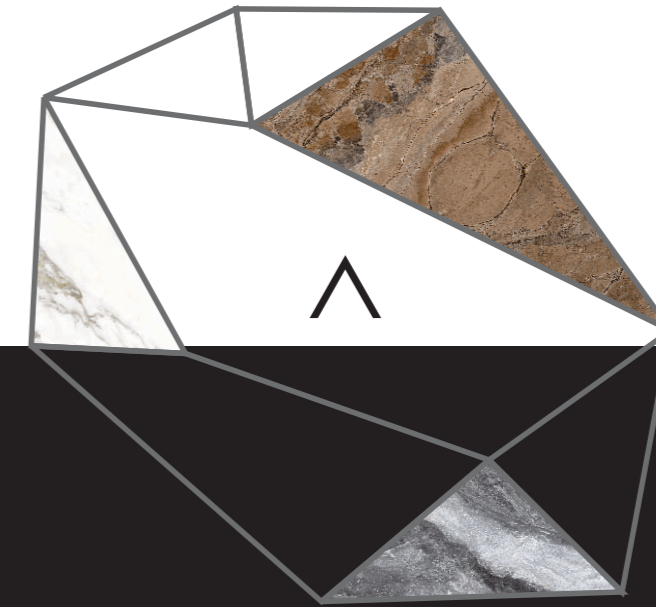

320X160CM
LARGE FORMAT
PORCELAIN SLABS

www.avantesurfaces.com

AVANTE™
PLUS
SLABS DE GRANDE

”

"DESIGN WITH INTENTION,
INSPIRE WITH GRANDIOSITY."



AVANTE™
PLUS
SLABS DE GRANDE

AvantePLUS is a large format porcelain slab category by AVANTE SURFACES. Inspired by nature, our product range is almost indistinguishable from elegant stones, ensuring the same aesthetics and luxurious feel without maintenance issues or usage restrictions.

Our slabs are easy to fabricate and process, enabling creative flexibility for a more personalized environment. So, whether building or remodelling your space, looking for a perfectly seamless look, or anything in between, AvantePLUS will cater to all your design needs.

A BRAND OF  **sati**, INDIA



DESIGNED WITH
GRANDEUR,
FOR GRANDEUR.

AVANTE™
PLUS
SLABS DE GRANDE

Available in **3200X1600mm** dimension and **12 mm thickness**, AvantePLUS slabs are highly versatile and suitable for all intended uses in both domestic and commercial settings.

Advantages of AvantePLUS



Hygienic & suitable for contact with food



Easy to clean



Resistant to chemicals acids, bases & solvents



Stain resistant



Resistant to mould mildew & fungus



Water resistant



Flatness & stability over time



Frost proof



Resistant to heat & high temperatures



UV resistant



Scratch proof & abrasion resistant



Impact resistant



AVANTE
PLUS
SLABS DE GRANDE

INDEX

Explore our
extensive collection

01 CALACATTA LIGHT	01 CALACATTA MIRROR	01 LINCOLN ORO	01 PIAGET WHITE	01 ARABESCATO ROYAL
01 BRECCIA CAPRAIA	01 STATUARIO GOLD GRANDE	01 CALACATTA ROYALE	01 STATUARIO MAGIA	01 VOLAKAS GRANDE
01 VALENCIA GOLD	01 STATUARIO GRANDE	01 VENETINO ROYAL	01 OYSTER BAY	01 CALACATTA VAGLI
01 BIANCO PANDA	01 VICTORIA GREY	01 PLUTO GRIS	01 AMAZONITE RUST	01 BAOBOB FURRY
01 CEPPO	01 OROBICO	01 MACABUS GOLD	01 ARMANI GREY GRANDE	01 PATAGONIA BIANCO
01 PATAGONIA STONE	01 HONEY ONYX	01 SUNSTONE BEIGE	01 PATAGONIA CLASSIC	01 PATAGONIA CRYSTALO
01 BRECCIA BRONZE	01 PIETRA NERO	01 AGATE CHARCOAL	01 WILLIAM NERO	01 LABRADORITE
01 NAPOLEAN GRANDE	01 SAHARA NOIR	01 HANDLING	01 TECHNICAL SPECIFICATION	

AVANTE™
PLUS

BookMatch
series

CALACATTA LIGHT
320x160cm (3200x1600mm | 63x126inch)

Finish:
Matt/Polished

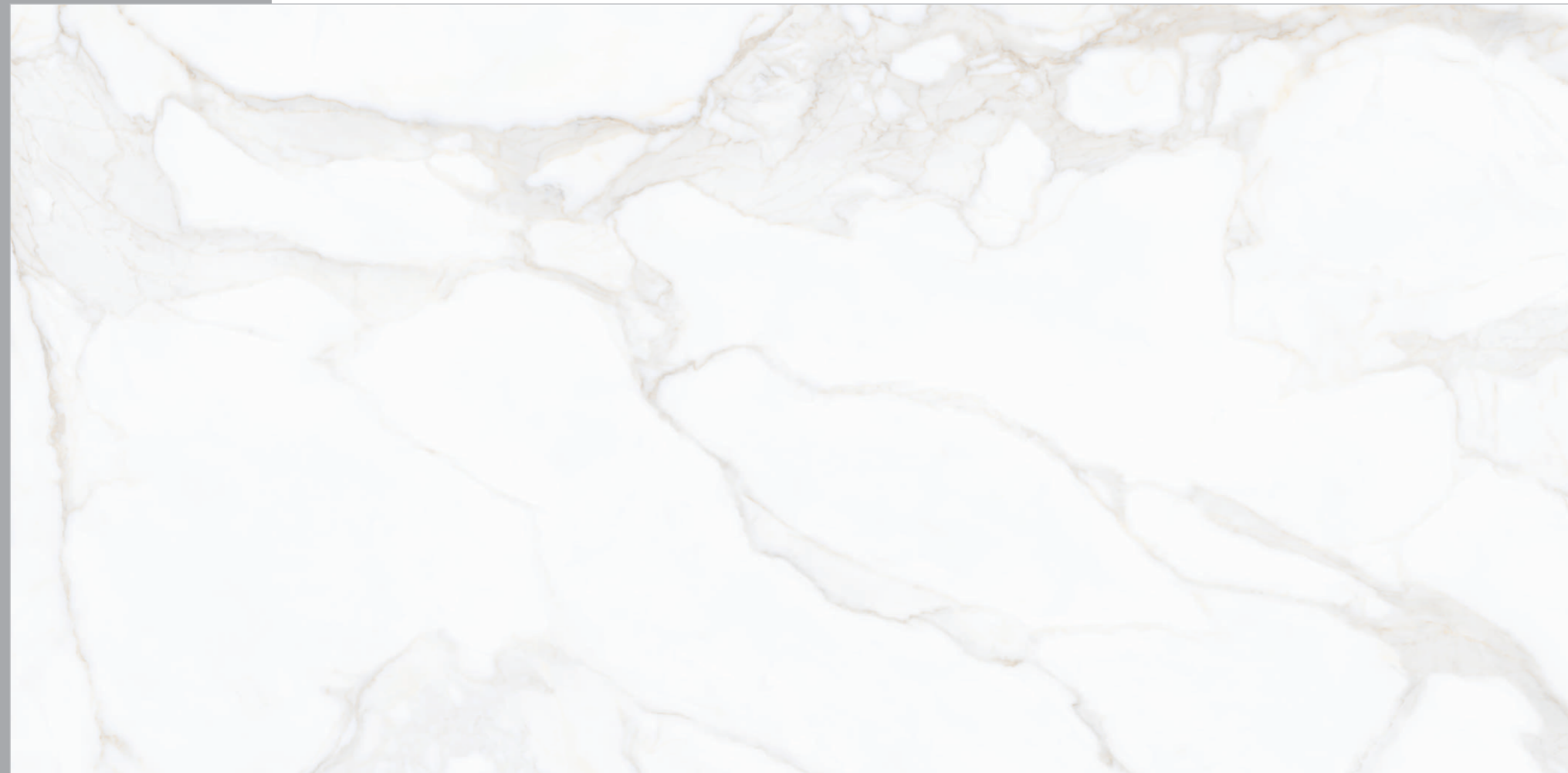

AVANTE™
PLUS

BookMatch
series

CALACATTA MIRROR
320x160cm (3200x1600mm | 63x126inch)

Finish:
Matt/Polished



AVANTE™
PLUS

BookMatch
series

LINCOLN ORO

320x160cm (3200x1600mm | 63x126inch)

Finish:
Matt/Polished



AVANTE™
PLUS

PIAGET WHITE

320x160cm (3200x1600mm | 63x126inch)

Finish:
Polished



AVANTE
PLUS

BookMatch
series

ARABESCATO ROYAL

320x160cm (3200x1600mm | 63x126inch)

Finish:
Matt/Polished



AVANTE
PLUS

BRECCIA CAPRAIA
320x160cm (3200x1600mm | 63x126inch)

Finish:
Polished



AVANTE™
PLUS

BookMatch
series

STATUARIO GOLD GRANDE

320x160cm (3200x1600mm | 63x126inch)

Finish:
Matt/Polished



AVANTE
PLUS

BookMatch
series

CALACATTA ROYALE

320x160cm (3200x1600mm | 63x126inch)

Finish:
Polished

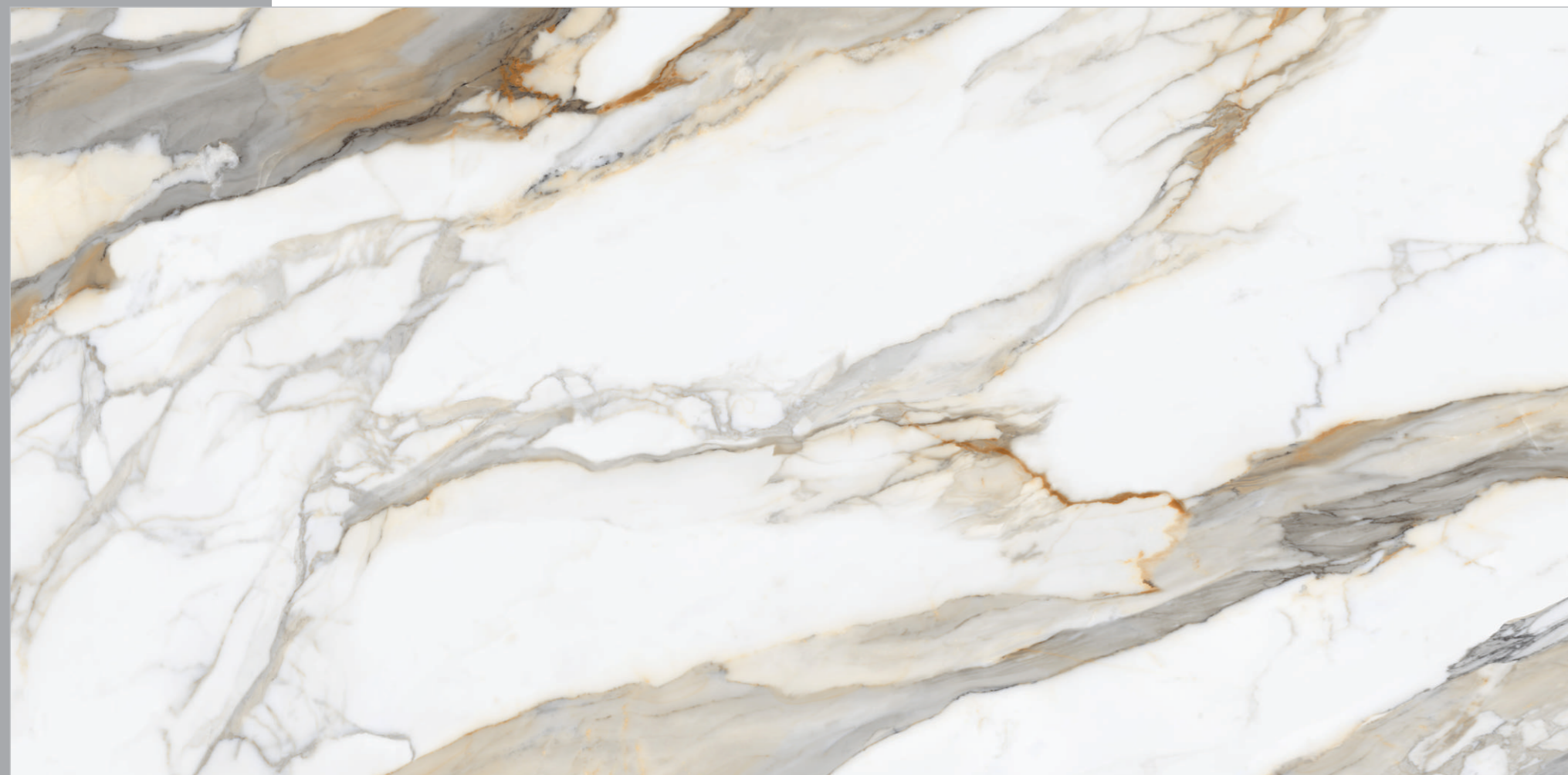

AVANTE
PLUS

BookMatch
series

STATUARIO MAGIA
320x160cm (3200x1600mm | 63x126inch)

Finish:
Matt\Polished



AVANTE
PLUS

VOLAKAS GRANDE
320x160cm (3200x1600mm | 63x126inch)

Finish:
Polished



AVANTE
PLUS

VALENCIA GOLD

320x160cm (3200x1600mm | 63x126inch)

Finish:
Polished



AVANTE™
PLUS

BookMatch
series

STATUARIO GRANDE

320x160cm (3200x1600mm | 63x126inch)

Finish:
Matt\Polished

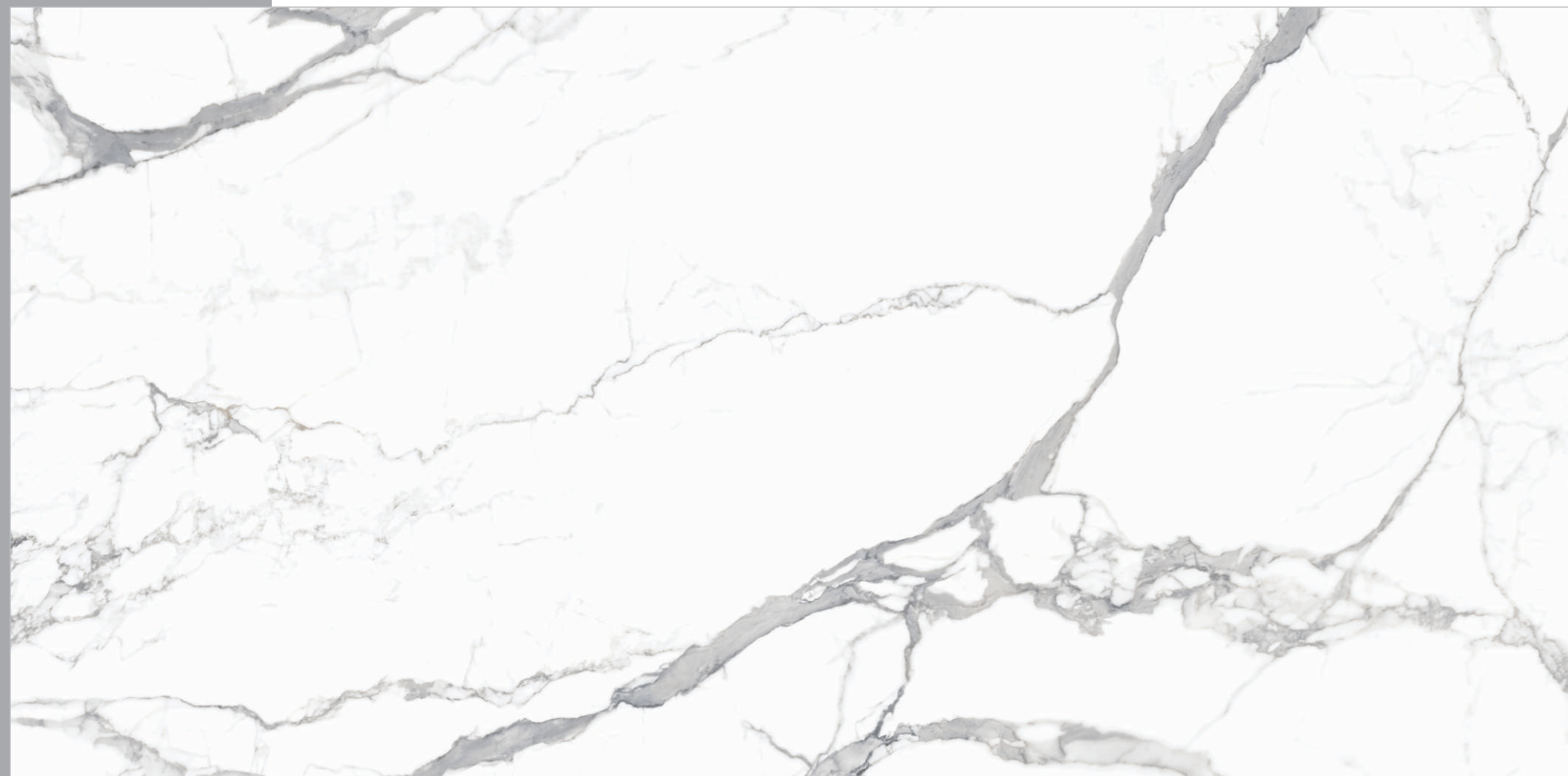

AVANTE™
PLUS

BookMatch
series

VENETINO ROYAL

320x160cm (3200x1600mm | 63x126inch)

Finish:
Matt\Polished



AVANTE™
PLUS

BookMatch
series

OYSTER BAY

320x160cm (3200x1600mm | 63x126inch)

Finish:
Polished



AVANTE™
PLUS

BookMatch
series

CALACATTA VAGLI
320x160cm (3200x1600mm | 63x126inch)

Finish:
Polished



AVANTE™
PLUS

BookMatch
series

BIANCO PANDA

320x160cm (3200x1600mm | 63x126inch)

Finish:
Polished



AVANTE™
PLUS

VICTORIA GREY

320x160cm (3200x1600mm | 63x126inch)

Finish:
Matt\Polished



AVANTE
PLUS

PLUTO GRIS

320x160cm (3200x1600mm | 63x126inch)

Finish:
Matt/Polished

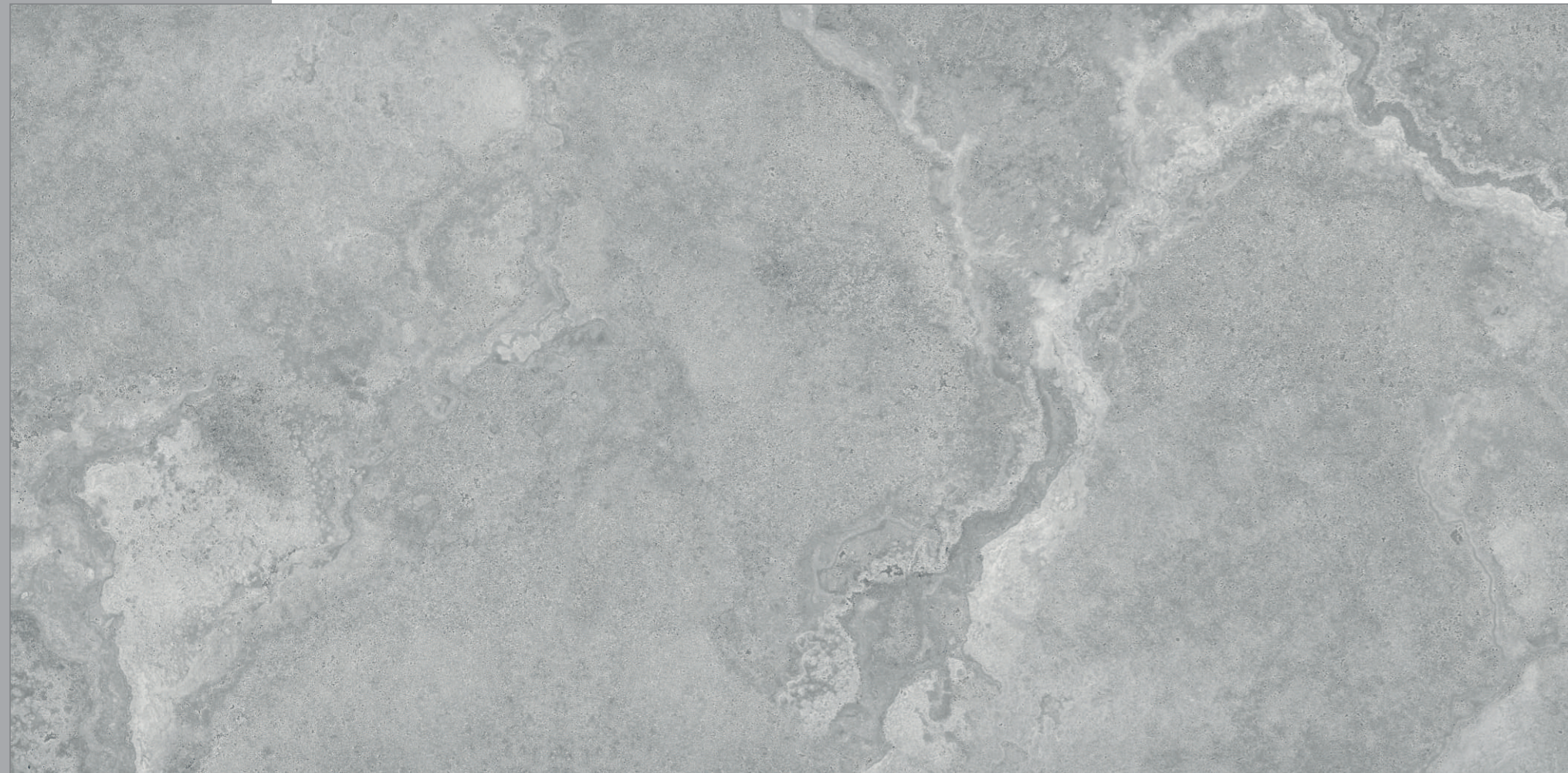

AVANTE
PLUS

AMAZONITE RUST

320x160cm (3200x1600mm | 63x126inch)

Finish:
Matt\Polished

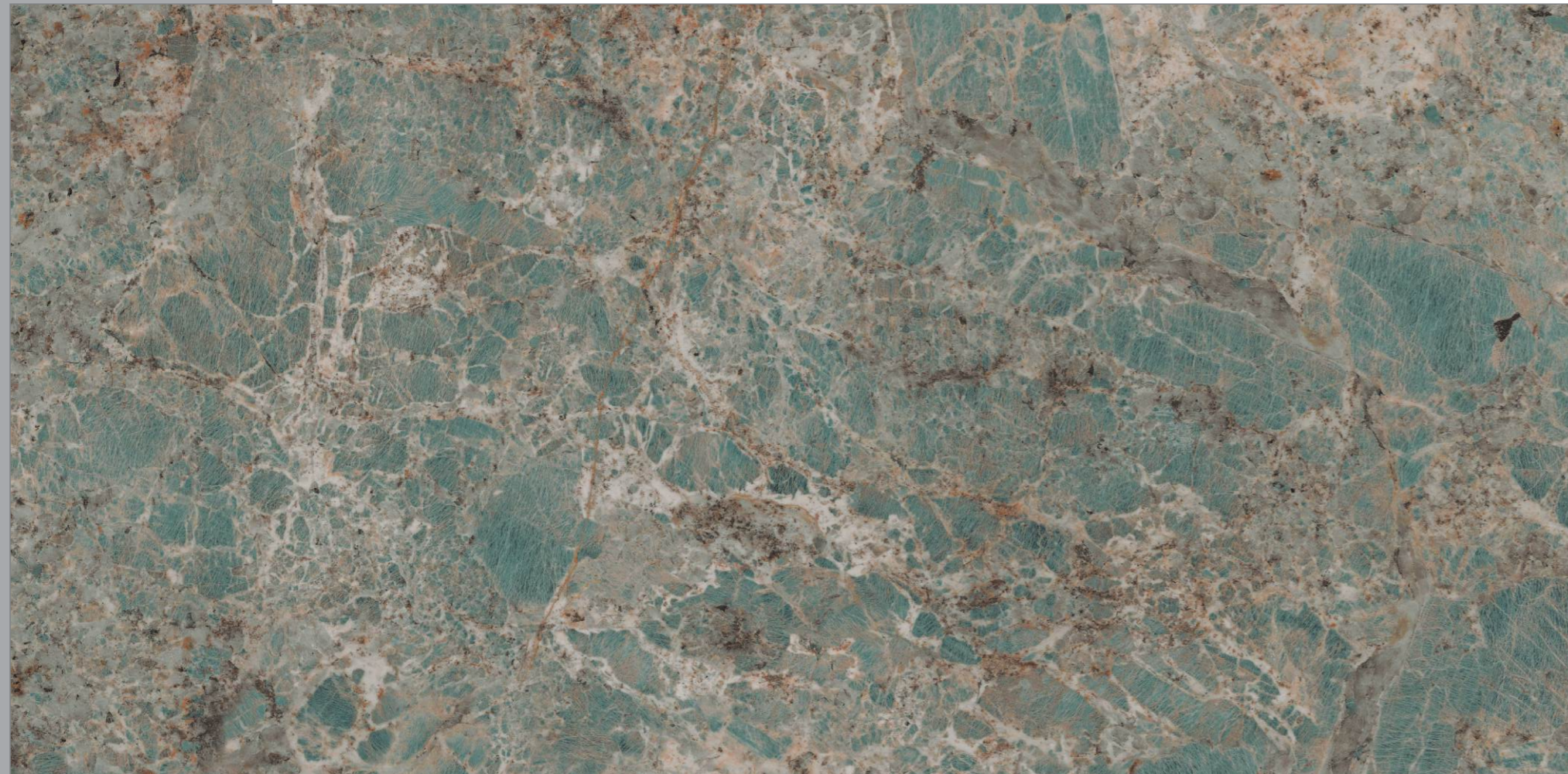

AVANTE™
PLUS

BookMatch
series

BAOBOB FURRY

320x160cm (3200x1600mm | 63x126inch)

Finish:
Matt\Polished



AVANTE
PLUS

CEPPO

320x160cm (3200x1600mm | 63x126inch)

Finish:
Matt\Polished

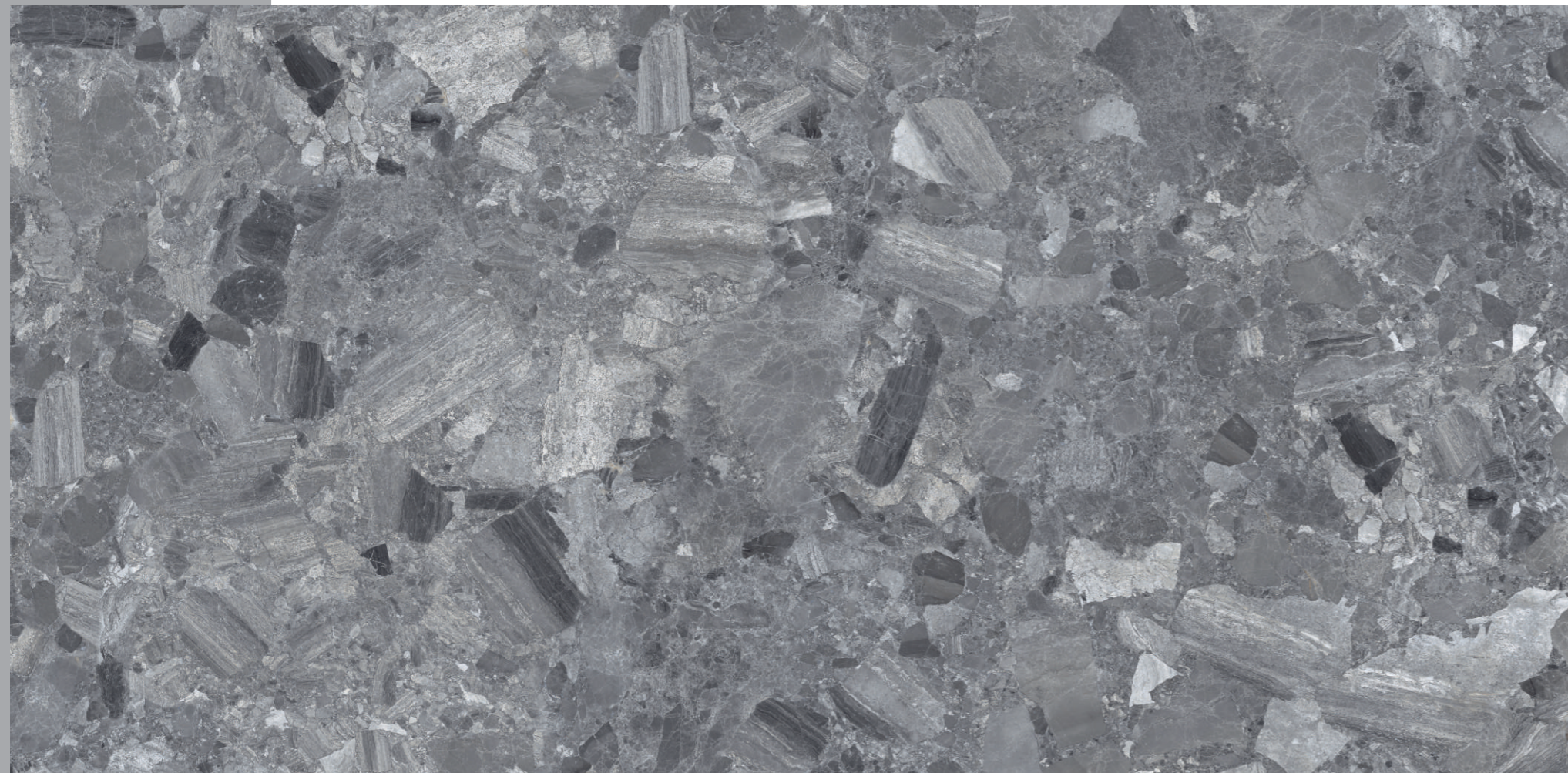

AVANTE
PLUS

OROBICO
320x160cm (3200x1600mm | 63x126inch)

Finish:
Matt\Polished

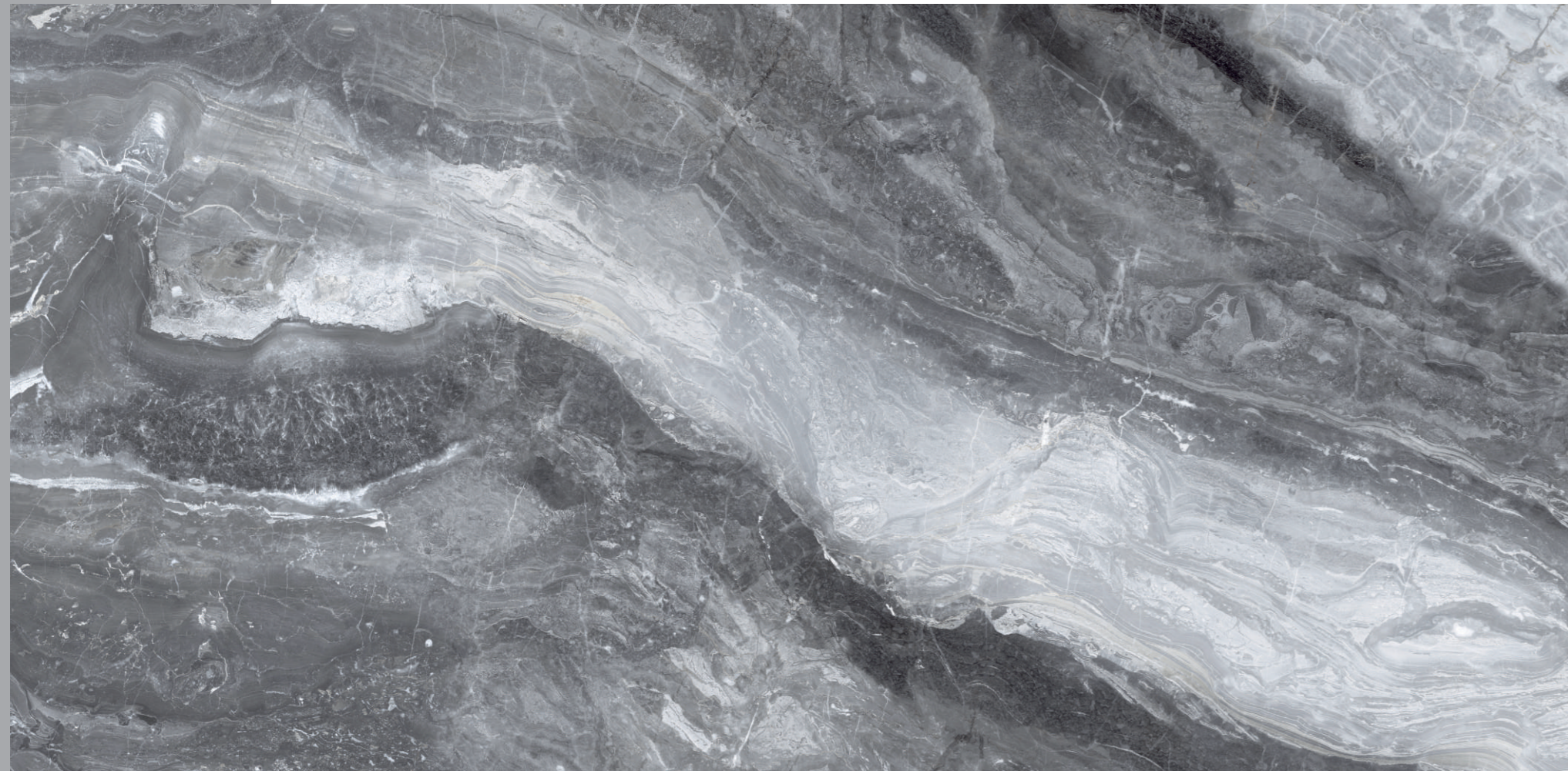

AVANTE
PLUS

MACABUS GOLD
320x160cm (3200x1600mm | 63x126inch)

Finish:
Matt/Polished

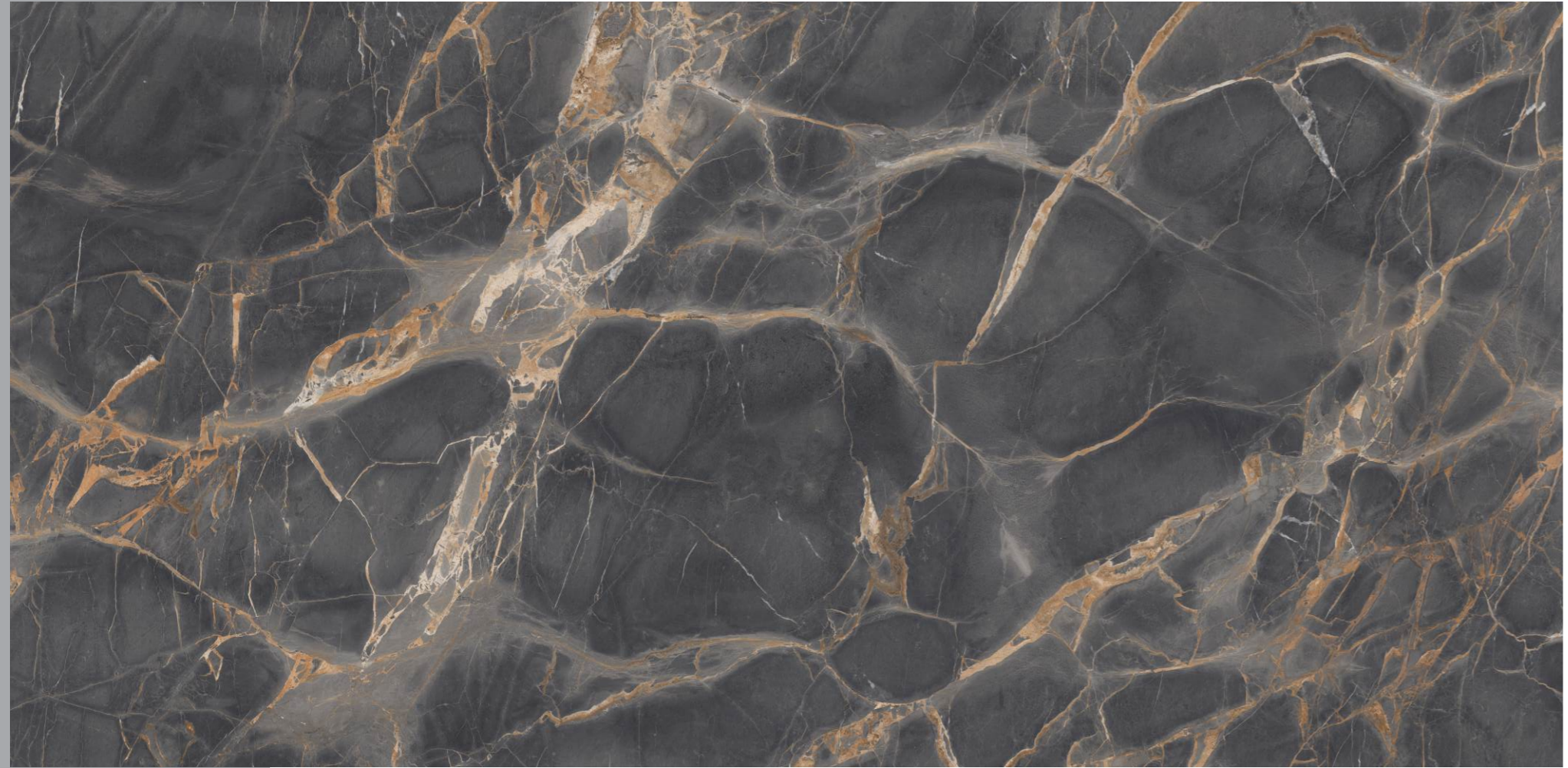

AVANTE™
PLUS

BookMatch
series

ARMANI GREY GRANDE

320x160cm (3200x1600mm | 63x126inch)

Finish:
Polished



AVANTE™
PLUS

BookMatch
series

PATAGONIA BIANCO

320x160cm (3200x1600mm | 63x126inch)

Finish:
Matt\Polished



AVANTE™
PLUS

BookMatch
series

PATAGONIA STONE

320x160cm (3200x1600mm | 63x126inch)

Finish:
Matt\Polished



AVANTE
PLUS

HONEY ONYX

320x160cm (3200x1600mm | 63x126inch)

Finish:
Matt/Polished



AVANTE
PLUS

SUNSTONE BEIGE
320x160cm (3200x1600mm | 63x126inch)

Finish:
Matt/Polished



AVANTE
PLUS

PATAGONIA CLASSIC

320x160cm (3200x1600mm | 63x126inch)

Finish:
Matt\Polished



AVANTE
PLUS

PATAGONIA CRYSTALO

320x160cm (3200x1600mm | 63x126inch)

Finish:
Matt\Polished



AVANTE™
PLUS

BookMatch
series

BRECCIA BRONZE

320x160cm (3200x1600mm | 63x126inch)

Finish:
Polished

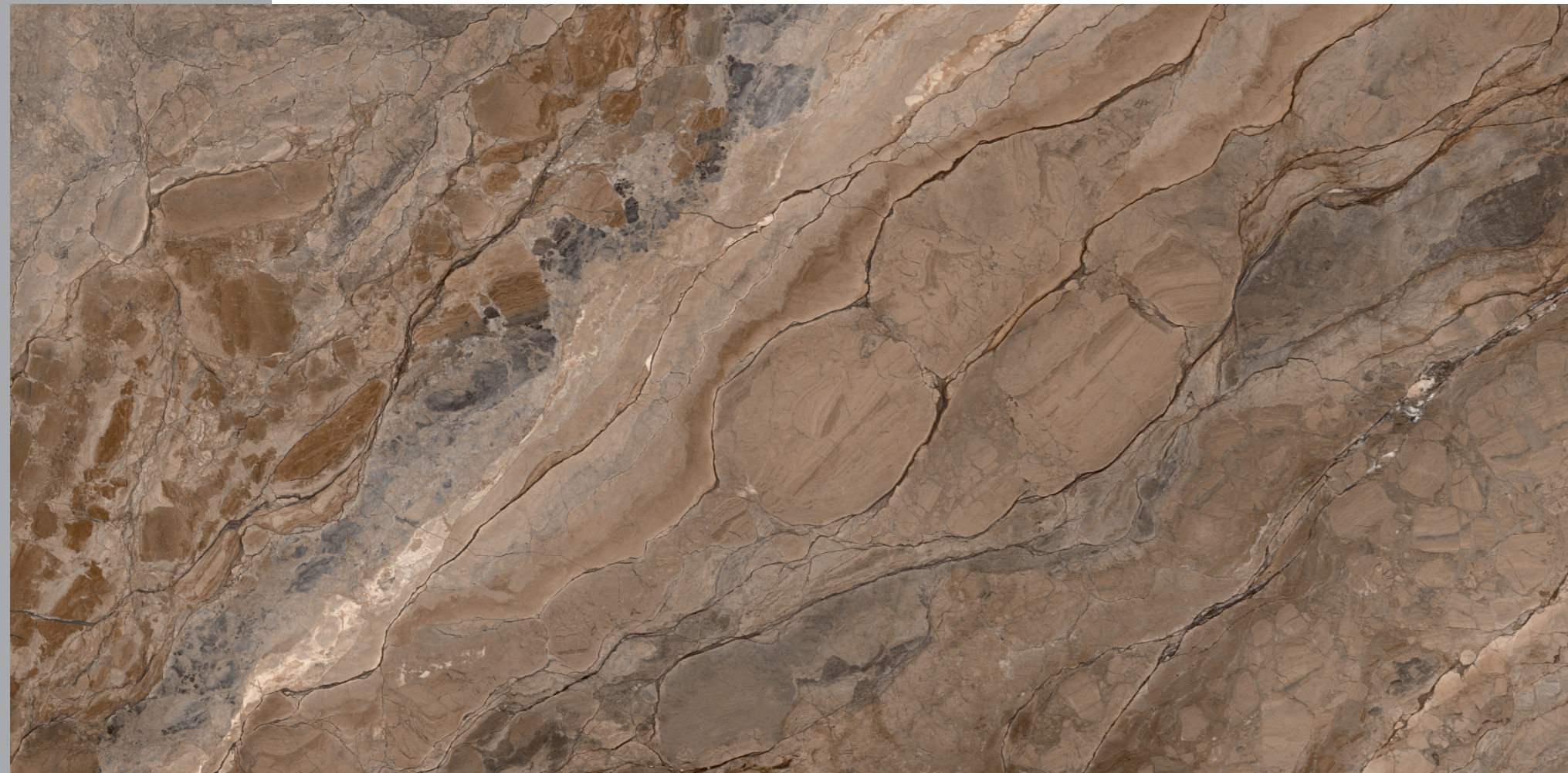

AVANTE™
PLUS

BookMatch
series

PIETRA NERO

320x160cm (3200x1600mm | 63x126inch)

Finish:
Matt\Polished



AVANTE™
PLUS

BookMatch
series

AGATE CHARCOAL

320x160cm (3200x1600mm | 63x126inch)

Finish:
Matt\Polished



AVANTE™
PLUS

BookMatch
series

WILLIAM NERO

320x160cm (3200x1600mm | 63x126inch)

Finish:
Matt\Polished



AVANTE
PLUS

LABRADORITE
320x160cm (3200x1600mm | 63x126inch)

Finish:
Polished

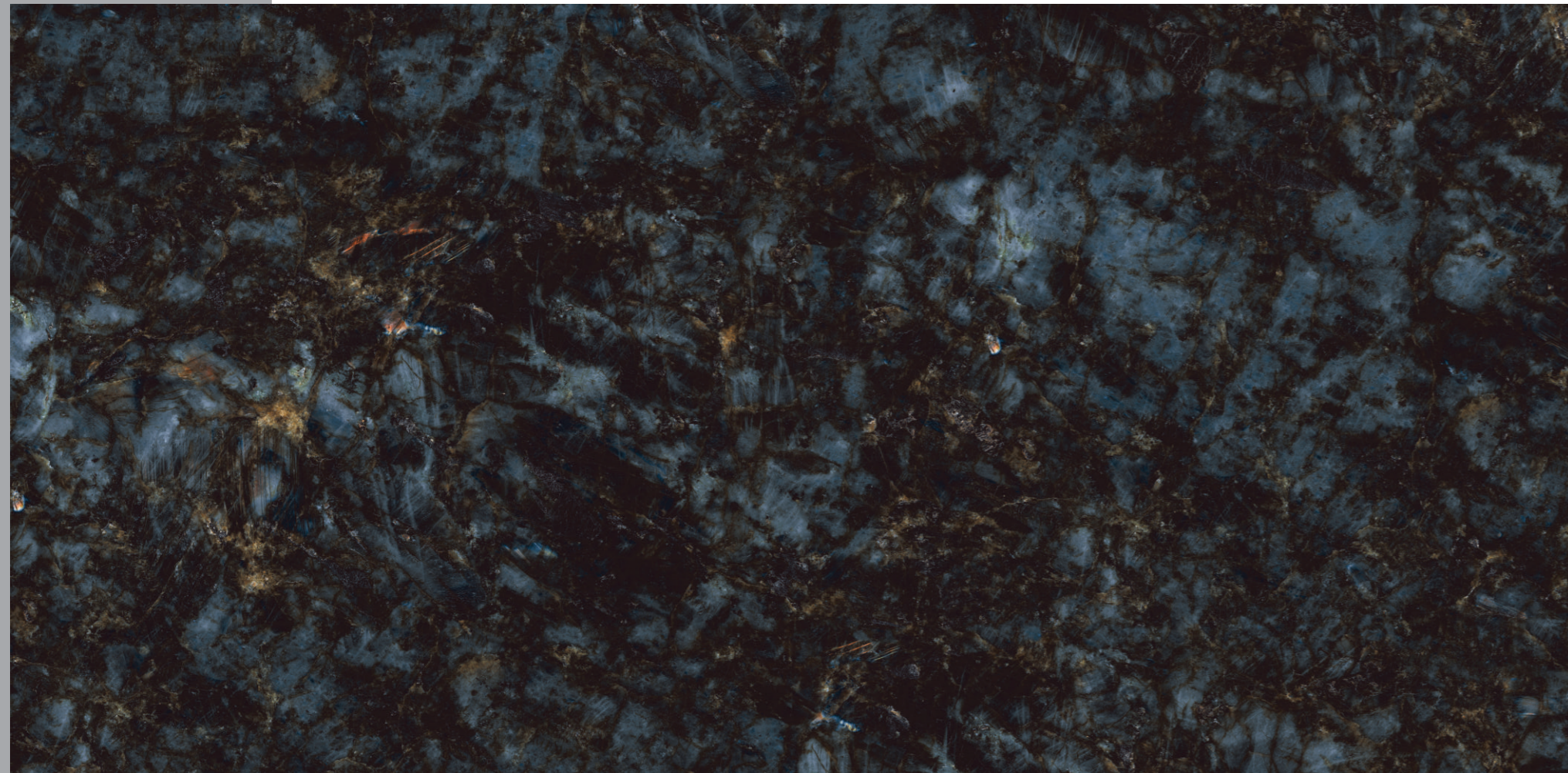

AVANTE
PLUS

BookMatch
series

NAPOLEAN GRANDE

320x160cm (3200x1600mm | 63x126inch)

Finish:
Polished

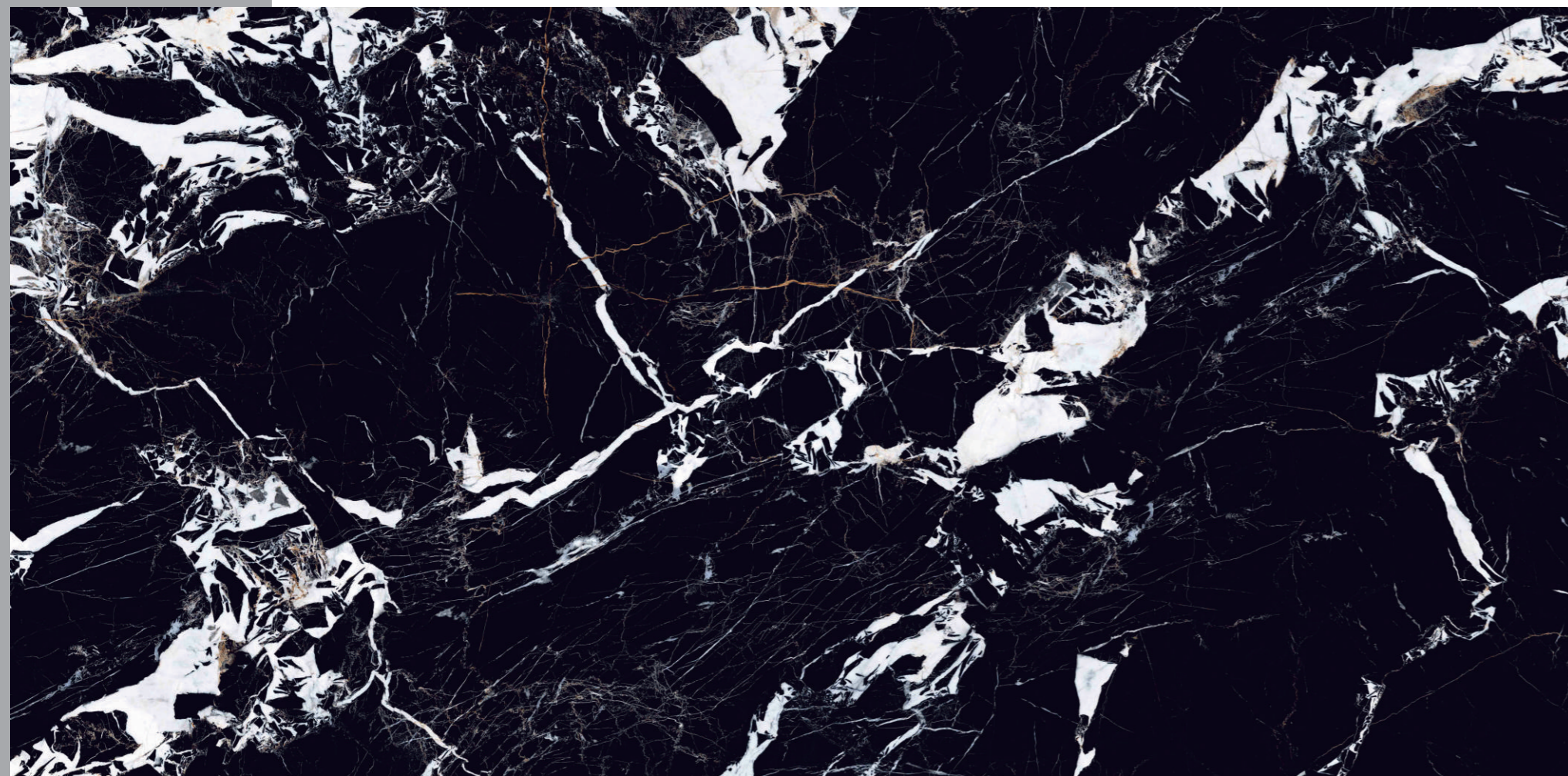

AVANTE
PLUS

BookMatch
series

SAHARA NOIR

320x160cm (3200x1600mm | 63x126inch)

Finish:
Matt\Polished

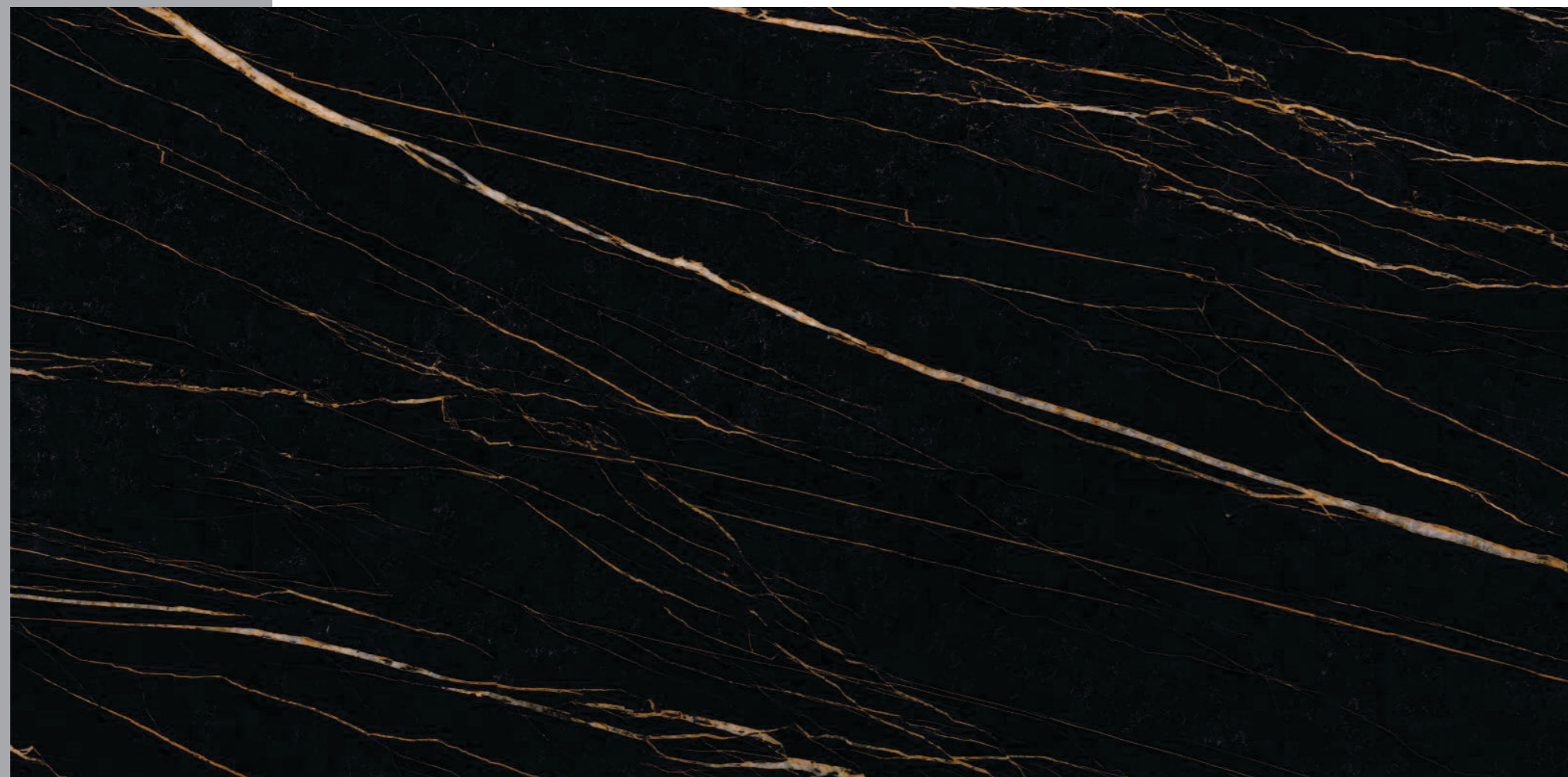

Handling

The cargo transport unit of AVANTE PLUS SLAB is formed on two "A-shaped" frames.

The sketches give us the necessary information for the handling and transport of trestles that support the slabs which need to only be moved one at a time. Recommendations, descriptions, measurements and weights shall mark the first steps to follow depending on the transport vehicle or the amount of material that it carries each time.

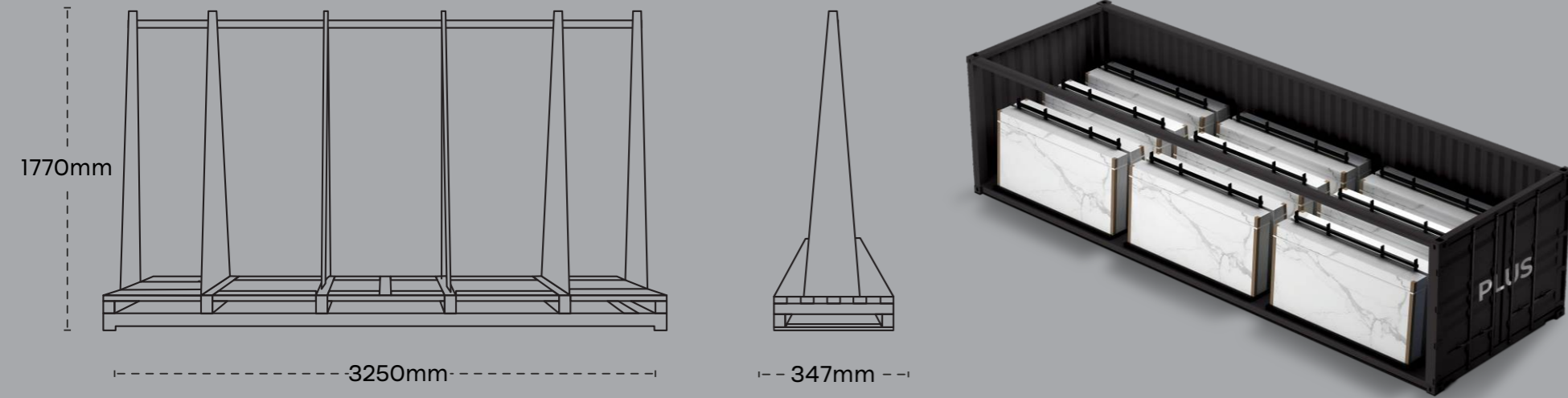

The trestle shall always be carried symmetrically and only one at a time to prevent instability or collapse.

Whenever the pallet has to be moved, it must be tied with at least one vertical sling. Place protective cardboard at the height of the ratchet to prevent it from hitting or scratching the workpiece. At rest, provided that the goods are not strapped or secured with slings, vertical poles must be placed to secure the load in the event of overturning.

A Frame Weight : 118kg

Size	Thickness	Weight / Slab	No. of Bundles or A-Frame	Total Slabs or Box	Slabs / Container	Sq mtr / Container	Weight / Container	Size of Container
3200x1600mm	12mm	147.0 kg	07	20 slabs	140	716.80	21.5 t	40 ft
3200x1600mm	12mm	147.0 kg	03	20 slabs	60	307.20	09.8 t	20 ft
3200x1600mm	12mm	147.0 kg	09	20 slabs	180	921.60	27.4 t	40 ft

TECHNICAL SPECIFICATION

CHARACTERISTIC	STANDARD AS PER ISO13006:2018/ EN14411 Gr.BIa	STANDARD AS PER IS 15622:2017 Gr.BIa	MEAN VALUE OF AVANTE PLUS	METHOD OF TESTING
Regulatory Properties				
Deviation in Length and Width	± 0.30 % (1.00 mm)	± 0.10 %	± 0.10 %	ISO 10545-2/IS 13630-1
Deviation in Thickness	± 5.0 % (0.50 mm)	± 5.0 %	± 5.0 %	ISO 10545-2/IS 13630-1
Straightness in Side	± 0.30 % (0.80 mm)	± 0.10 %	± 0.10 %	ISO 10545-2/IS 13630-1
Rectangularity	± 0.30 % (1.50 mm)	± 0.10%	± 0.10 %	ISO 10545-2/IS 13630-1
Surface Flatness Central Curvature	± 0.40 % (1.80 mm)	± 0.50 %	± 0.20 %	ISO 10545-2/IS 13630-1
Surface Flatness Edge Curvature	± 0.40 % (1.80 mm)	± 0.50 %	± 0.20 %	ISO 10545-2/IS 13630-1
Surface Flatness Warpage	± 0.40 % (1.80 mm)	± 0.50 %	± 0.10 %	ISO 10545-2/IS 13630-1
Surface Quality	>95% defects free	>95% defects free	>95% defects free	ISO 10545-2/IS 13630-1
Small Color Difference (For Plain Colour)	Δ E <1.00	N.A.	Δ E <0.80	ISO 10545-16
Glossiness (Polished)	As per Manufacturer	As per Manufacturer	= 90	Gloss Meter 60
Glossiness (Satin/Posh)	As per Manufacturer	As per Manufacturer	7 = Gloss Value = 25	Gloss Meter 60
Structural Properties				
Water Absorption	≤ 0.50 %	≤ 0.080 %	≤ 0.080 %	ISO 10545-3/IS 13630-2
Bulk Density	As per Manufacturer	Min 2.20 g/cc	> 2.28 gm/cc	ISO 10545-3/IS 13630-2
Massive Mechanical Properties				
Modulus of Rupture	Min. 35.0 N/mm	Min. 35.0 N/mm	Min. 40.0 N/mm	SO 10545-4/IS 13630-6
Breaking Strength Thickness =7.5 mm	Min 1300.0 N	Min 1300.0 N	Min 6000.0 N	ISO 10545-4/IS 13630-6
Surface Mechanical Properties				
MOH S Hardness #	As per Manufacturer	Min. 5	Polished Min 4**/ Satin & Posh Min 6	BS EN 15771/IS 13630-13
Surface Abrasion Resistance #	As per Manufacturer	Min. Class II	Polished Min II**/ Satin & Posh Min III	ISO 10545-7/IS 13630-11
Thermal Hygrometric Properties				
Moisture Expansion	Max 0.06% (0.6 mm/m)	Max 0.02 mm/m	Max 0.02 mm/m	ISO 10545-10/IS 13630-3
Thermal Expansion(COE) at 100 C	As per Manufacturer	Max. 6.0 x 10-6	Max. 6.0 x 10-6	ISO 10545-8/IS 13630-4
Thermal Shock Resistance	Min 10 Cycle	Min 10 Cycle	Min 10 Cycle	ISO 10545-9/IS 13630-5
Impact Resistance(COR) #	Min. 0.55	Min 0.55	Min 0.55	ISO 10545-5/IS 13630-14
Frost Resistance	As per Manufacturer	As per Manufacturer	Frost Proof	ISO 10545-12/IS 13630-10
Crazing Resistance at 7.5 bar	4 Cycle	4 Cycle	4 Cycle	ISO 10545-11/IS 13630-9
Chemical Properties				
Resistance to Staining Glazed	Min. Class 3	Min Class 1	Min. Class 3/Min. Class 1	ISO 10545-14/IS 13630-8
Resistance to Household Chemicals & Swimming Pool Salts Glazed	Min Class GB	Min Class AA	Min Class GB/Min Class AA	ISO 10545-13/IS 13630-8
Resistance to Low Concentrate	As per Manufacturer	As per Manufacturer	Min Class GLB***/ Min Class A***	ISO-10545-13/IS 13630-8
Acid and Alkalis Glazed	As per Manufacturer	As per Manufacturer	Min Class CHB***/ Min Class A***	ISO-10545-13/IS 13630-8
Resistance to High Concentrate	As per Manufacturer	As per Manufacturer		
Acid and Alkalis Glazed				
Safety Properties				
Skid Resistance - (DCOF-WET PENDULUM)##	As per Manufacturer	As per Manufacturer	Glossy:P0,Satin,Posh:P1	BS 7976-2
Slip Resistance -Satin/Posh (DCOF- R Value)##	As per Manufacturer	As per Manufacturer	R9 to R10	DIN 51130
Lead and Cadmium release	As per Manufacturer	N.A.	Does not yield Pb & Cd	ISO-10545-15

* Whichever is Lower

** With nano technology (Polished Vitrified tiles) Depending on Application area (low or high intensity of traffic)

*** Except Hydrofluoric Acid & it's compound

Tiles Intended for use on floor | ## For Floor tiles,as per customer requirement



AVANTE™
PLUS
SLABS DE GRANDE